

Article number: 3213323

Description: Ortlinghaus Coupling size 23

Measures

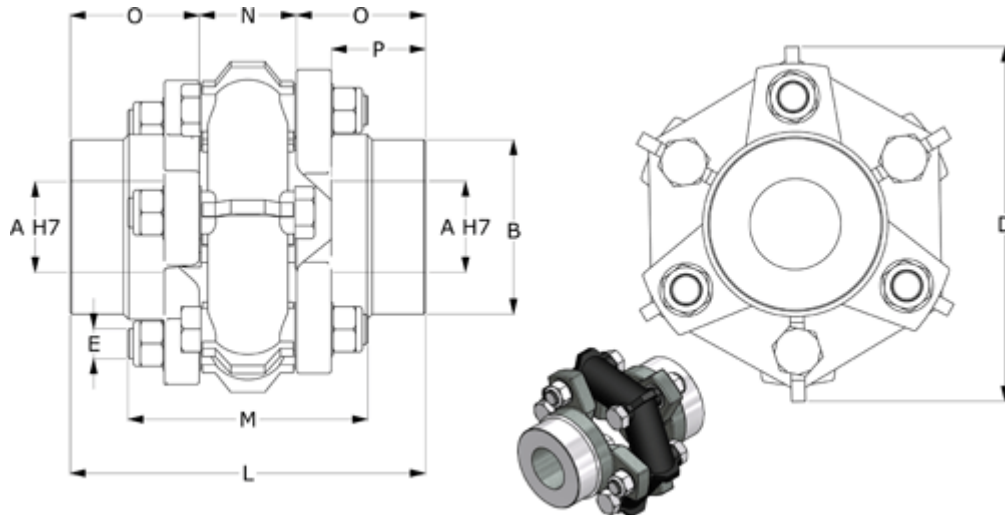

A max H7	= 40	M	= 84	Tightening torque N m	= 47
Axial displacement mm	= +/-3	Moment of inertia kg/m ²	= 0.00100	Weight	= 1.8
B	= 58	N	= 36		
Bending angle	= +/-2,8	O	= 44		
C	= 85	P	= 36		
D	= 118	Radial displacement	= +/-0,6		
E	= M10	Standard running NM	= 80		
L	= 124	Stress load Nm	= 200		